

1 Canopy can be installed on vehicle with or without tub liner.

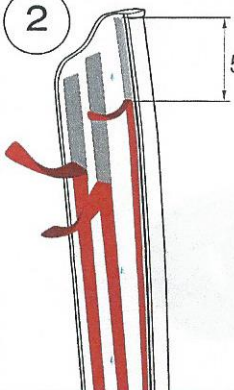

2 5 CM.



Peel off the adhesive lining from the tailgate lip weather strip by about 5 cm.

3

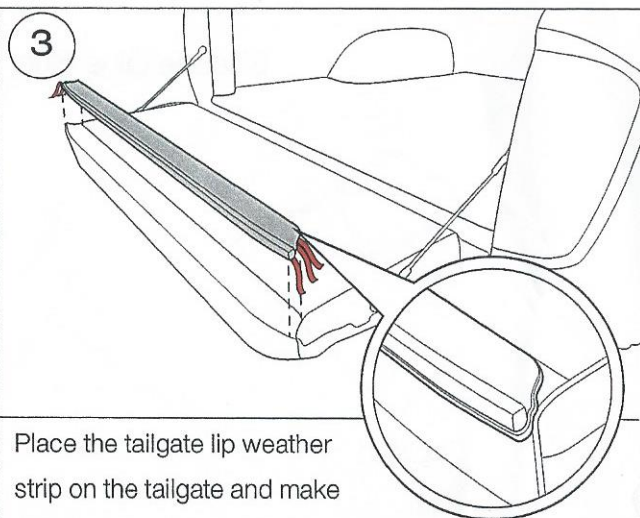

Place the tailgate lip weather strip on the tailgate and make adjustments such that the ends are spaced equally apart.

4

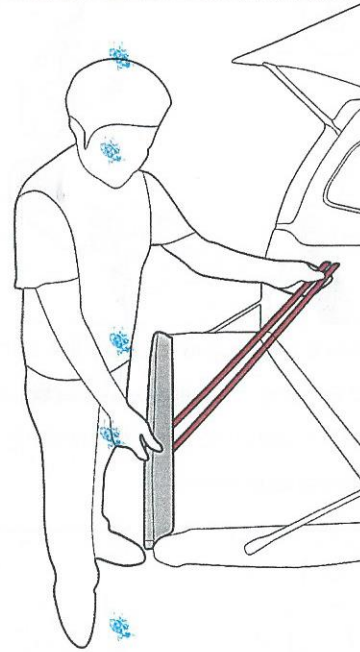

5

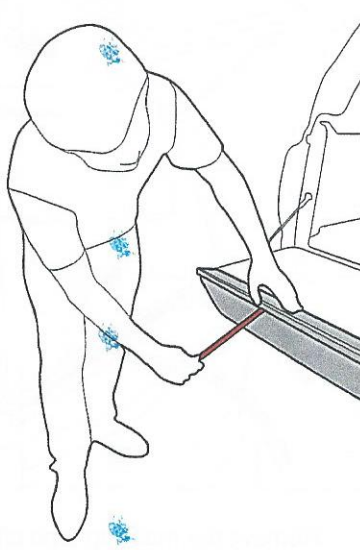

Remove the rest of the adhesive lining.

6

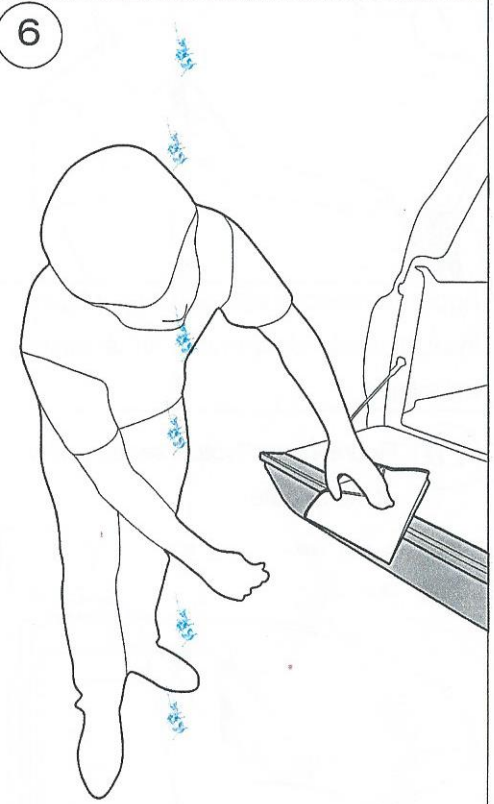

Use the cloth to apply pressure to the Weather Strip for adhering the strip to the tailgate and also to smooth out any unevenness.

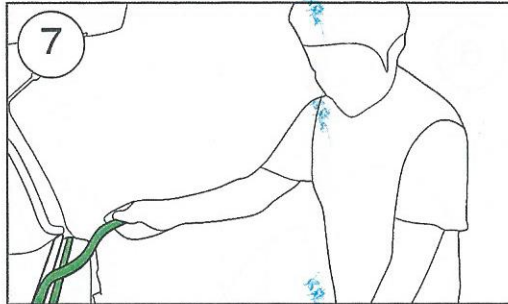

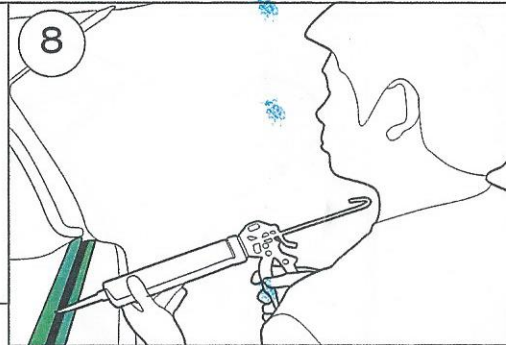

Apply the masking tape at A as per figure inset, that extends along the full length of the tailgate.



Use the glue gun to apply the silicone glue at B along the tailgate as per figure inset.
Use a rubber to smooth out the glue for a continuous seam.

7a Figure inset : Typical section view of the tailgate.

-  Masking Tape
-  Silicone

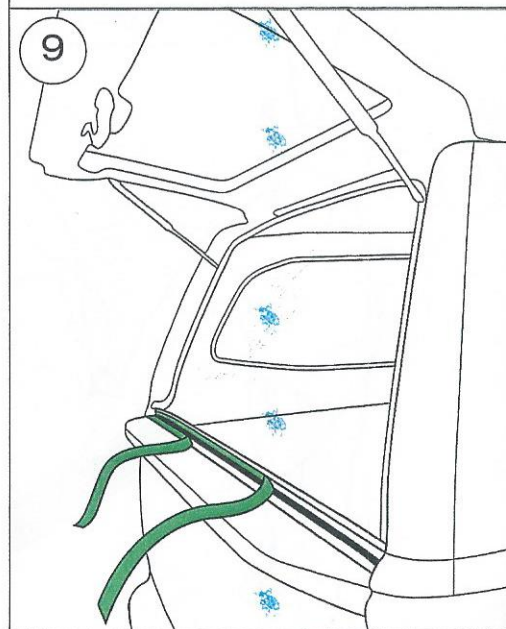
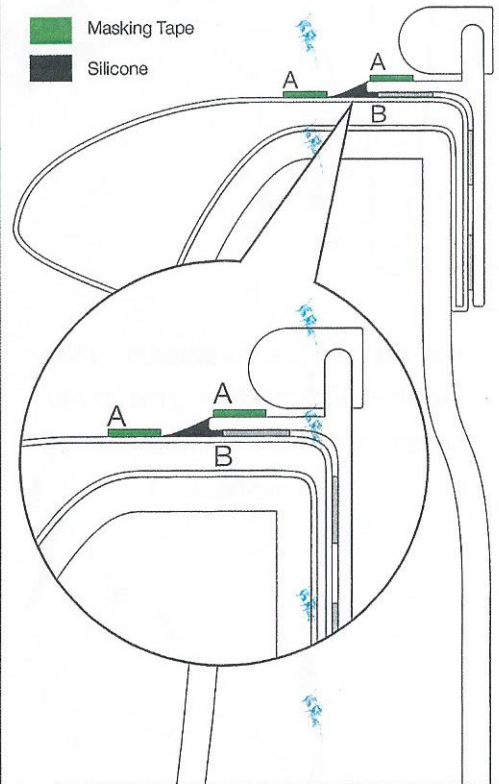

Remove the masking tape after the silicone glue has been applied.

Installation Manual For Tailgate Lip Weather Strip

TOOL

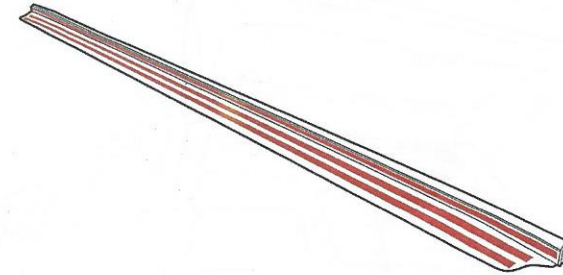

Tailgate Lip Weather Strip

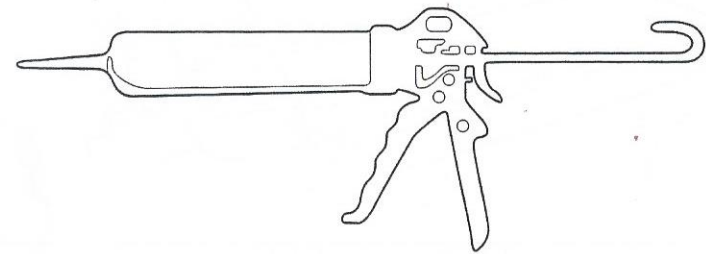

Silicone Glue Gun

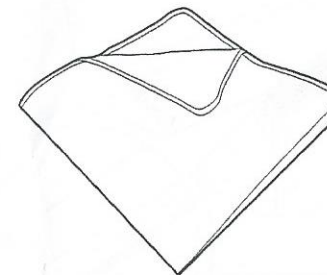

Cloth



Masking Tape